

When using power tools, be sure to follow the "safety-rules" for the tool!
SAFETY FIRST!!!

Rail Procedure:

Select 3/8" stock by desired width and length.

1. Set blade angle to 10° and depth of cut to 1/8". Set fence 5/16" from blade.
2. Make four cuts as shown.
3. Move fence to opposite side of blade. Set fence 1/16" from blade. Make four cuts as shown.
4. Set Blade to 0° and depth of cut to 1/8" and remove material as shown.
5. Cut top of rail to 1/4" as shown.
6. Set fence 3/8" from blade and cut rail from stock.

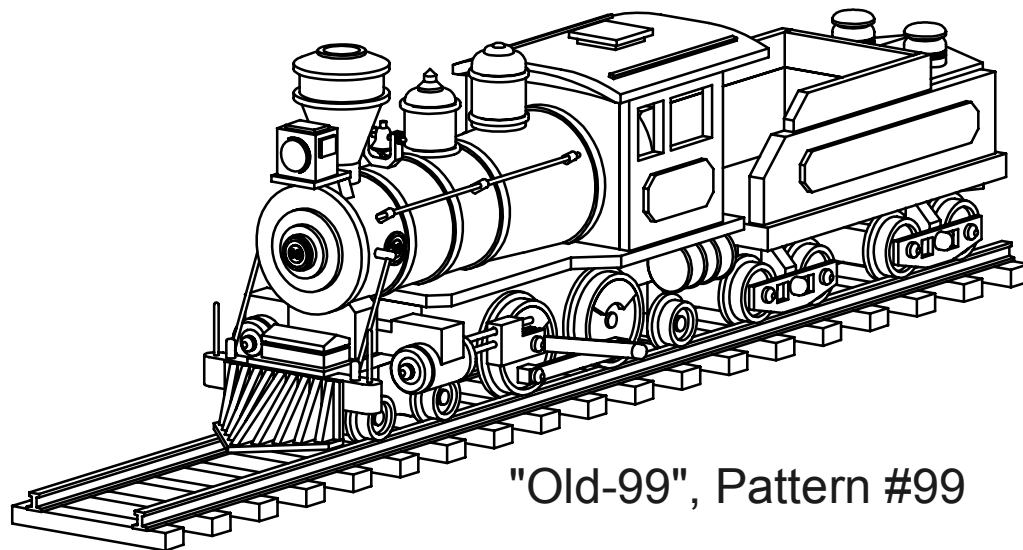

"Old-99", Pattern #99

Train Track

Toys and Joys, Inc P.O. Box 628, Lynden, WA 98264

9/16/2006	SHEET TITLE	PATTERN NUMBER
SHEET 1 OF 2	Track Assembly	RR-T

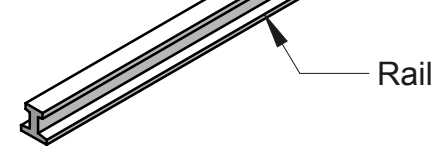
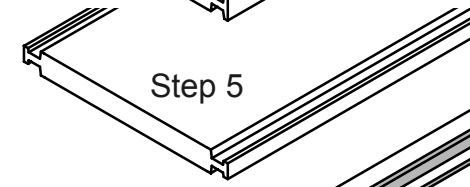
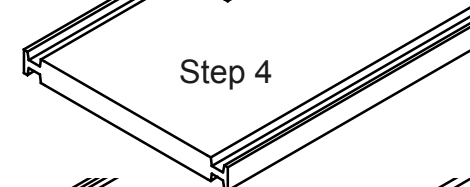
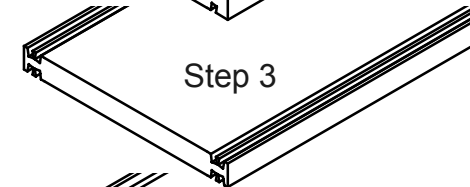
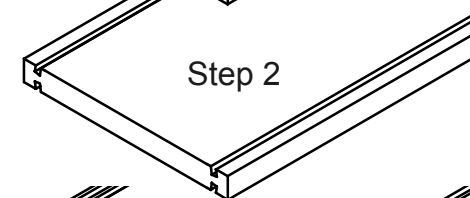
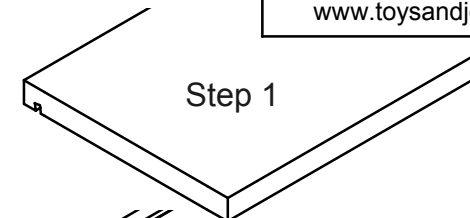
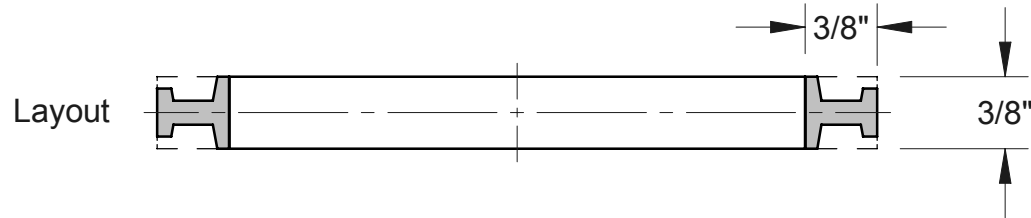

FENCE

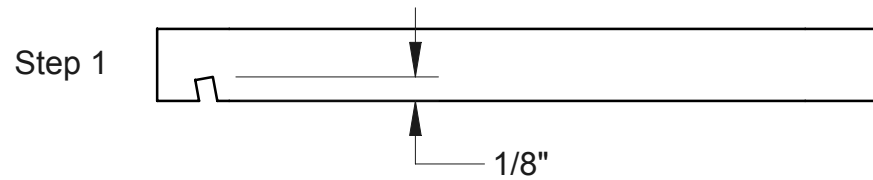

FENCE

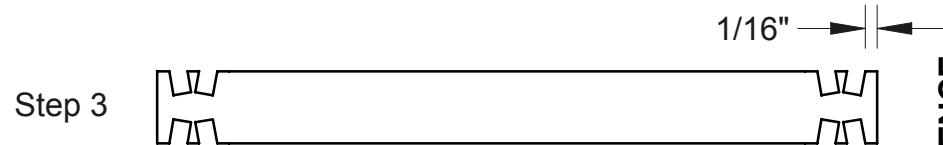

FENCE

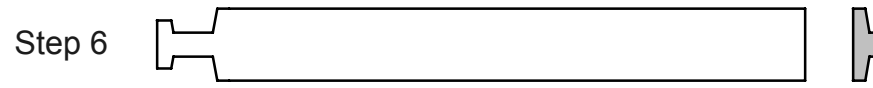
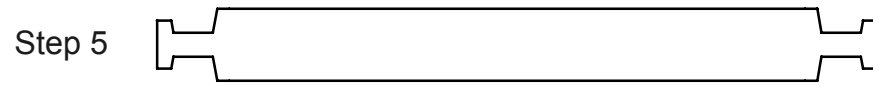

FENCE

1/8"

1/4"

3/8"

Train Track

Toys and Joys, Inc P.O. Box 628, Lynden, WA 98264

9/16/2006

SHEET TITLE

PATTERN NUMBER

SHEET 2 OF 2

Rail Cuts

RR-T